

# 36V, 5MHz Rail-to-Rail Output CMOS Operational Amplifier

## 1 FEATURES

- **High Gain Bandwidth: 5MHz**
- **Input Offset Voltage:  $\pm 0.9\text{mV}$  (Typical)**
- **Quiescent Current: 1.8mA/Amp**
- **Rail to Rail Output**
- **Supply Range: +4.4V to +36V**
- **Specified Up to +125°C**
- **Micro Size Packages: SOP8, MSOP8, SOP14**

## 2 APPLICATIONS

- **Sensors**
- **Photodiode Amplification**
- **Active Filters**
- **Test Equipment**
- **Driving A/D Converters**

## 3 DESCRIPTIONS

The RS842X families of products offer high voltage (36V) operation and rail-to-rail output, as well as excellent speed/power consumption ratio, providing an excellent bandwidth (5MHz) and slew rate of  $3\text{V}/\mu\text{s}$ . The op-amps are unity gain stable and feature an ultra-low input bias current.

The devices are stable at capacitance up to 300pF. The input can operate normally within the negative power rail to 2V below of the positive power rail. The RS842X families of operational amplifiers are specified at the full temperature range of  $-40^\circ\text{C}$  to  $+125^\circ\text{C}$  under single power supplies of 4.4V to 36V or dual power supplies of  $\pm 2.2\text{V}$  to  $\pm 18\text{V}$ .

**Device Information <sup>(1)</sup>**

PART NUMBER	PACKAGE	BODY SIZE(NOM)
RS8422	SOP8	4.90mm x 3.90mm
	MSOP8	3.00mm x 3.00mm
RS8424	SOP14	8.65mm x 3.90mm

(1) For all available packages, see the orderable addendum at the end of the data sheet.

---

## Table of Contents

<b>1 FEATURES</b> .....	1
<b>2 APPLICATIONS</b> .....	1
<b>3 DESCRIPTIONS</b> .....	1
<b>4 REVISION HISTORY</b> .....	3
<b>5 PACKAGE/ORDERING INFORMATION</b> <sup>(1)</sup> .....	4
<b>6 PIN CONFIGURATION AND FUNCTIONS</b> .....	5
<b>7 SPECIFICATIONS</b> .....	7
7.1 Absolute Maximum Ratings .....	7
7.2 ESD Ratings .....	7
7.3 Recommended Operating Conditions.....	7
7.4 Electrical Characteristics.....	8
7.5 Typical Characteristics .....	10
<b>8 PACKAGE OUTLINE DIMENSIONS</b> .....	12
<b>9 TAPE AND REEL INFORMATION</b> .....	15

## 4 REVISION HISTORY

Note: Page numbers for previous revisions may differ from page numbers in the current version.

<b>VERSION</b>	<b>Change Date</b>	<b>Change Item</b>
A.1	2020/12/4	Initial version completed
A.2	2021/6/21	1. Fix TSSOP-14 Package mistake in Page 12 in A.1 Version 2. Added the value of Input Voltage Noise Density 3. Added the information of package size
A.3	2024/03/06	1. Added MSL 2. Update Quiescent Current 3. Modify packaging naming
A.4	2024/12/23	1. Delete RS8421XF/RS8421BXF/RS8424XQ Orderable Devices 2. Delete content related to RS8421

**5 PACKAGE/ORDERING INFORMATION (1)**

Orderable Device	Package Type	Pin	Channel	Op Temp(°C)	Device Marking <sup>(2)</sup>	MSL <sup>(3)</sup>	Package Qty
RS8422XK	SOP8	8	2	-40°C ~125°C	RS8422	MSL3	Tape and Reel,4000
RS8422XM	MSOP8	8	2	-40°C ~125°C	RS8422	MSL3	Tape and Reel,4000
RS8424XP	SOP14	14	4	-40°C ~125°C	RS8424	MSL3	Tape and Reel,4000

## NOTE:

- (1) This information is the most current data available for the designated devices. This data is subject to change without notice and revision of this document. For browser-based versions of this data sheet, refer to the right-hand navigation.
- (2) There may be additional marking, which relates to the lot trace code information (data code and vendor code), the logo or the environmental category on the device.
- (3) RUNIC classify the MSL level with using the common preconditioning setting in our assembly factory conforming to the JEDEC industrial standard J-STD-20F. Please align with RUNIC if your end application is quite critical to the preconditioning setting or if you have special requirement.

## 6 PIN CONFIGURATION AND FUNCTIONS

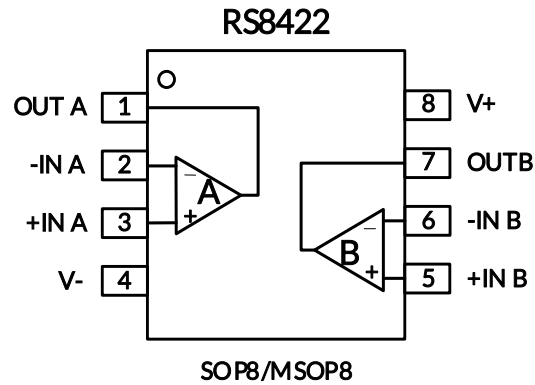

### Pin Description

NAME	PIN	I/O <sup>(1)</sup>	DESCRIPTION
	SOP8/MSOP8		
-INA	2	I	Inverting input, channel A
+INA	3	I	Noninverting input, channel A
-INB	6	I	Inverting input, channel B
+INB	5	I	Noninverting input, channel B
OUTA	1	O	Output, channel A
OUTB	7	O	Output, channel B
V-	4	-	Negative (lowest) power supply or ground (for single supply operation)
V+	8	-	Positive (highest) power supply

(1) I = Input, O = Output.



## 7 SPECIFICATIONS

### 7.1 Absolute Maximum Ratings

Over operating free-air temperature range (unless otherwise noted) <sup>(1)</sup>

		MIN	MAX	UNIT
Voltage	Supply, $V_S=(V+) - (V-)$	-0.7	36	V
	Signal input pin <sup>(2)</sup>	(V-) -0.2	(V+) +0.2	
	Signal output pin <sup>(3)</sup>	(V-) -0.2	(V+) +0.2	
Current	Signal input pin <sup>(2)</sup>	-10	10	mA
	Signal output pin <sup>(3)</sup>	-100	100	mA
	Output short-circuit <sup>(4)</sup>	Continuous		
$\theta_{JA}$	Package thermal impedance <sup>(5)</sup>	SOP8	110	°C/W
		MSOP8	170	
		SOP14	105	
Temperature	Operating range, $T_A$	-40	125	°C
	Junction, $T_J$ <sup>(6)</sup>	-40	150	
	Storage, $T_{stg}$	-55	150	

(1) Stresses above these ratings may cause permanent damage. Exposure to absolute maximum conditions for extended periods may degrade device reliability. These are stress ratings only, and functional operation of the device at these or any other conditions beyond those specified is not implied.

(2) Input terminals are diode-clamped to the power-supply rails. Input signals that can swing more than 0.2V beyond the supply rails should be current-limited to 10mA or less.

(3) Output terminals are diode-clamped to the power-supply rails. Output signals that can swing more than 0.2V beyond the supply rails should be current-limited to  $\pm 100$ mA or less.

(4) Short-circuit to ground, one amplifier per package.

(5) The package thermal impedance is calculated in accordance with JESD-51.

(6) The maximum power dissipation is a function of  $T_{J(MAX)}$ ,  $R_{\theta JA}$ , and  $T_A$ . The maximum allowable power dissipation at any ambient temperature is  $P_D = (T_{J(MAX)} - T_A) / R_{\theta JA}$ . All numbers apply for packages soldered directly onto a PCB.

### 7.2 ESD Ratings

The following ESD information is provided for handling of ESD-sensitive devices in an ESD protected area only.

		VALUE	UNIT
$V_{(ESD)}$	Electrostatic discharge	Human-Body Model (HBM)	$\pm 5000$
		Machine Model (MM)	$\pm 200$

(1) JEDEC document JEP155 states that 500-V HBM allows safe manufacturing with a standard ESD control process.



### ESD SENSITIVITY CAUTION

ESD damage can range from subtle performance degradation to complete device failure. Precision integrated circuits may be more susceptible to damage because very small parametric changes could cause the device not to meet its published specifications.

### 7.3 Recommended Operating Conditions

Over operating free-air temperature range (unless otherwise noted)

		MIN	NOM	MAX	UNIT
Supply voltage, $V_S=(V+) - (V-)$	Single-supply	4.4		36	V
	Dual-supply	$\pm 2.2$		$\pm 18$	

## 7.4 Electrical Characteristics

(At  $T_A = +25^\circ\text{C}$ ,  $V_S = 4.4\text{V}$  to  $36\text{V}$ ,  $R_L = 10\text{k}\Omega$  connected to  $V_S/2$ , and  $V_{OUT} = V_S/2$ ,  $V_{CM} = V_S/2$ , Full <sup>(9)</sup> =  $-40^\circ\text{C}$  to  $+125^\circ\text{C}$ , unless otherwise noted.) <sup>(1)</sup>

PARAMETER		CONDITIONS	$T_J$	RS842X			UNITS
				MIN <sup>(2)</sup>	TYP <sup>(3)</sup>	MAX <sup>(2)</sup>	
<b>POWER SUPPLY</b>							
$V_S$	Operating Voltage Range		$25^\circ\text{C}$	4.4		36	V
$I_Q$	Quiescent Current Per Amplifier	$V_S = \pm 2.5\text{V}$ , $I_O = 0\text{mA}$	$25^\circ\text{C}$		1.8	3.3	mA
		$V_S = \pm 18\text{V}$ , $I_O = 0\text{mA}$			2.0	4.0	
PSRR	Power-Supply Rejection Ratio	$V_S = 4.4\text{V}$ to $36\text{V}$	$25^\circ\text{C}$	100	120		dB
<b>INPUT</b>							
$V_{OS}$	Input Offset Voltage	$V_{CM} = V_S/2$	$25^\circ\text{C}$	-3	$\pm 0.9$	3	mV
			Full		$\pm 1.4$		
$V_{OS} T_C$	Input Offset Voltage Average Drift		Full		5		$\mu\text{V}/^\circ\text{C}$
$I_B$	Input Bias Current <sup>(4) (5)</sup>	$V_{CM} = 0\text{V}$	$25^\circ\text{C}$		10	60	pA
			Full		600		
$I_{OS}$	Input Offset Current <sup>(5)</sup>	$V_{CM} = 0\text{V}$	$25^\circ\text{C}$		10	60	pA
			Full		600		
$V_{CM}$	Common-Mode Voltage Range	$V_S = \pm 18\text{V}$	$25^\circ\text{C}$	(V-)		(V+)-2	V
CMRR	Common-Mode Rejection Ratio	$V_S = \pm 2.5\text{V}$ , $V_{CM} = (V-) \text{ to } (V+) - 2\text{V}$	$25^\circ\text{C}$	70	110		dB
		$V_S = \pm 18\text{V}$ , $V_{CM} = (V-) \text{ to } (V+) - 2\text{V}$	$25^\circ\text{C}$	70			
<b>OUTPUT</b>							
$A_{OL}$	Open-Loop Voltage Gain	$R_L = 10\text{k}\Omega$ , $V_O = (V-) + 0.5\text{V}$ to $(V+) - 0.5\text{V}$	$25^\circ\text{C}$	88	100		dB
			Full		90		
$V_{OH}$	Output Swing	$V_S = \pm 18\text{V}$ , $R_L = 10\text{k}\Omega$	$25^\circ\text{C}$	17.85			V
$V_{OL}$						-17.85	V
$I_{SC}$	Short-circuit current <sup>(6) (7)</sup>	$V_S = 36\text{V}$ , $V_O = 0\text{V}$	$25^\circ\text{C}$		90		mA
$C_{LOAD}$	Capacitive load drive		$25^\circ\text{C}$		100		pF
<b>FREQUENCY RESPONSE</b>							
SR	Slew Rate <sup>(8)</sup>	$G = +1$ , $C_L = 100\text{pF}$	$25^\circ\text{C}$		3		$\text{V}/\mu\text{s}$
GBW	Gain-Bandwidth Product		$25^\circ\text{C}$		5		MHz
$t_S$	Settling Time, 0.01%	$V_S = \pm 2.5\text{V}$ , $G = +1$ , $C_L = 100\text{pF}$ , Step=2V	$25^\circ\text{C}$		1.0		$\mu\text{s}$
$t_{OR}$	Overload Recovery Time	$V_{IN} \cdot \text{Gain} \geq V_S$ , $G = 11$	$25^\circ\text{C}$		1.5		$\mu\text{s}$
$t_{ON}$	Turn On Time		$25^\circ\text{C}$		10		$\mu\text{s}$
<b>NOISE</b>							
$E_n$	Input Voltage Noise	$f = 0.1\text{Hz}$ to $10\text{Hz}$ , $V_S = \pm 2.5\text{V}$	$25^\circ\text{C}$		7.5		$\mu\text{V}_{pp}$
$e_n$	Input Voltage Noise Density	$f = 1\text{kHz}$	$25^\circ\text{C}$		44		$\text{nV}/\sqrt{\text{Hz}}$



**NOTE:**

- (1) Electrical table values apply only for factory testing conditions at the temperature indicated. Factory testing conditions result in very limited self-heating of the device.
- (2) Limits are 100% production tested at 25°C. Limits over the operating temperature range are ensured through correlations using statistical quality control (SQC) method.
- (3) Typical values represent the most likely parametric norm as determined at the time of characterization. Actual typical values may vary over time and will also depend on the application and configuration.
- (4) Positive current corresponds to current flowing into the device.
- (5) This parameter is ensured by design and/or characterization and is not tested in production.
- (6) The maximum power dissipation is a function of  $T_{J(MAX)}$ ,  $R_{\theta JA}$ , and  $T_A$ . The maximum allowable power dissipation at any ambient temperature is  $PD = (T_{J(MAX)} - T_A) / R_{\theta JA}$ . All numbers apply for packages soldered directly onto a PCB.
- (7) Short circuit test is a momentary test.
- (8) Number specified is the slower of positive and negative slew rates.
- (9) Specified by characterization only.

## 7.5 Typical Characteristics

NOTE: The graphs and tables provided following this note are a statistical summary based on a limited number of samples and are provided for informational purposes only.

At  $T_A = +25^\circ\text{C}$ ,  $V_S = \pm 18\text{V}$ ,  $R_L = 10\text{k}\Omega$  connected to  $V_S/2$ ,  $V_{OUT} = V_S/2$ , unless otherwise noted.

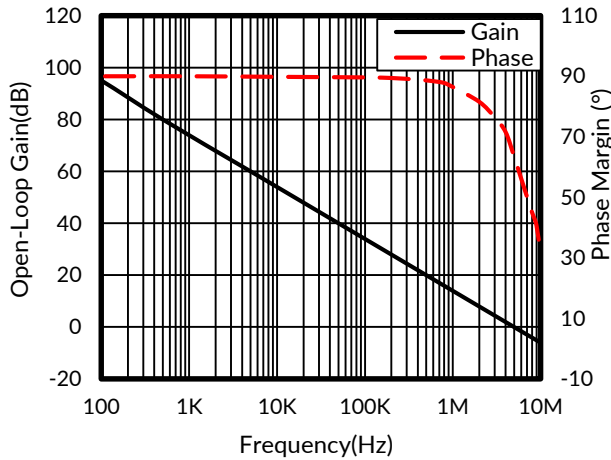

**Figure 1. Open-Loop Gain And Phase vs Frequency**

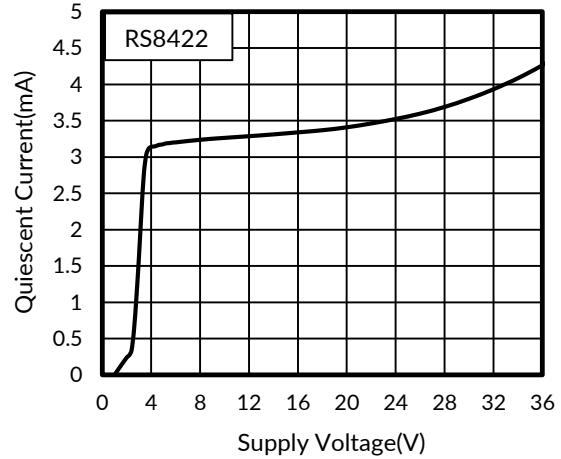

**Figure 2. Supply Voltage vs Quiescent Current**

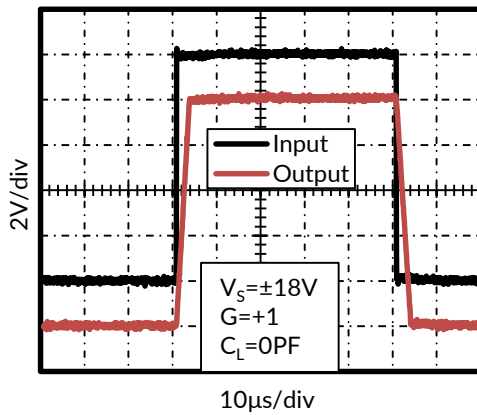

**Figure 3. Large Signal Step Response**

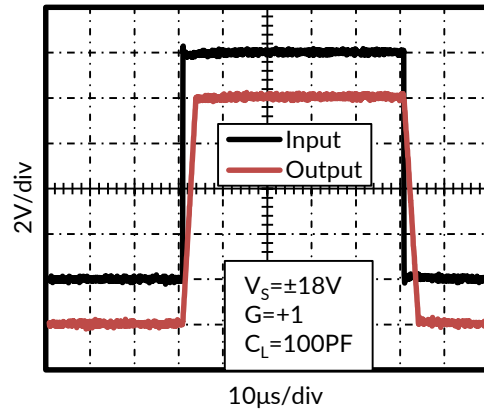

**Figure 4. Large Signal Step Response**

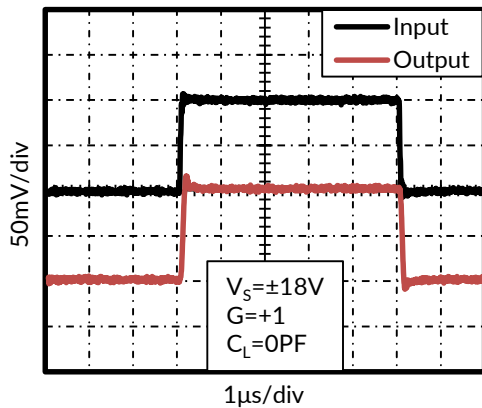

**Figure 5. Small Signal Step Response**

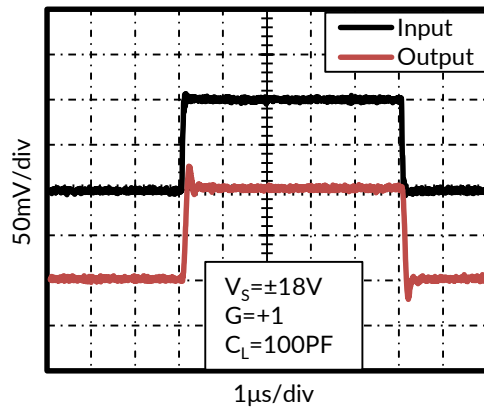

**Figure 6. Small Signal Step Response**

### Typical Characteristics

NOTE: The graphs and tables provided following this note are a statistical summary based on a limited number of samples and are provided for informational purposes only.

At  $T_A = +25^\circ\text{C}$ ,  $V_S = \pm 18\text{V}$ ,  $R_L = 10\text{k}\Omega$  connected to  $V_S/2$ ,  $V_{OUT} = V_S/2$ , unless otherwise noted.

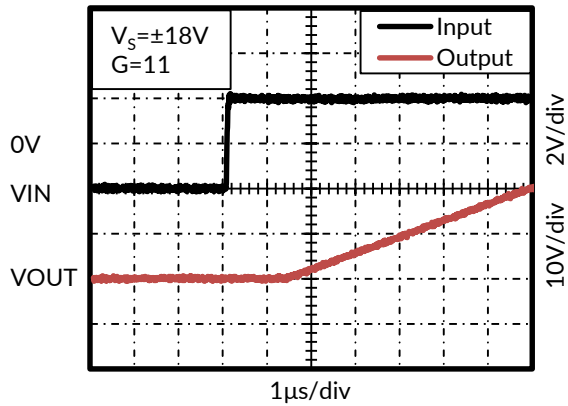

Figure 7. Positive Overvoltage Recovery

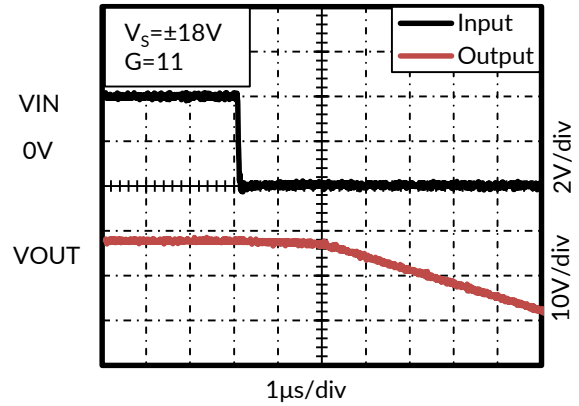

Figure 8. Negative Overvoltage Recovery

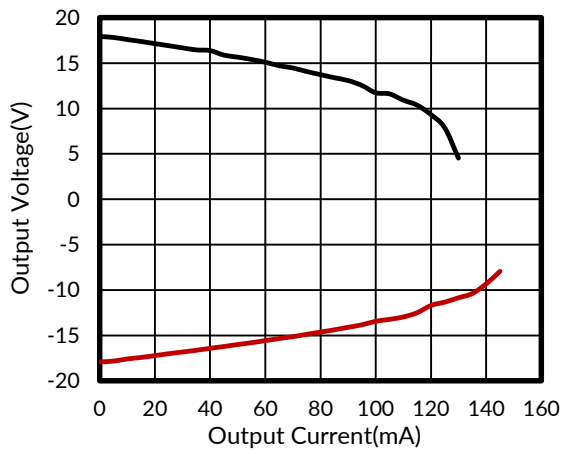

Figure 9. Output Voltage Swing vs Output Current

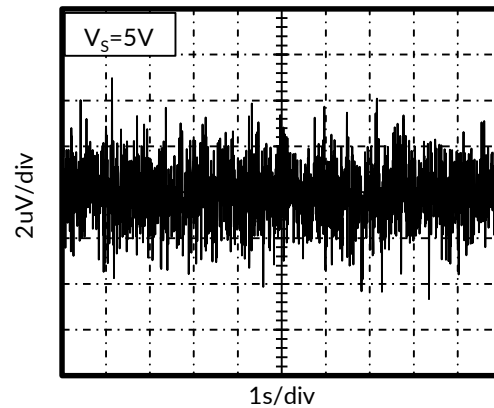
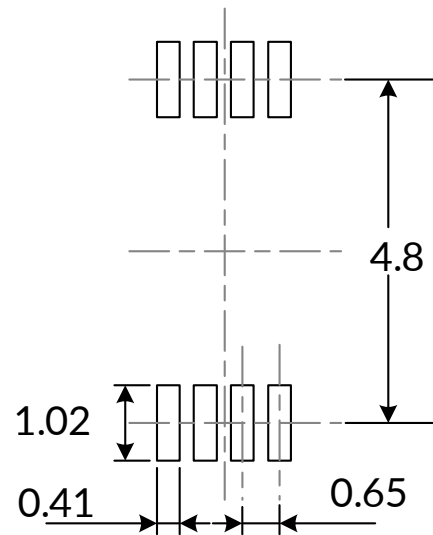
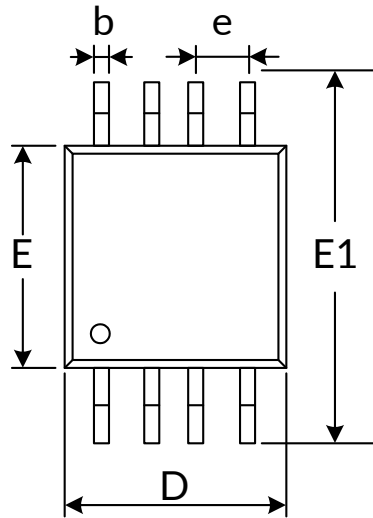
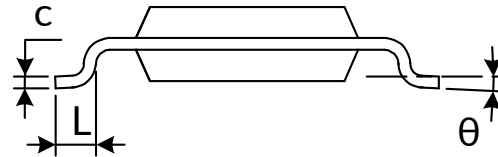
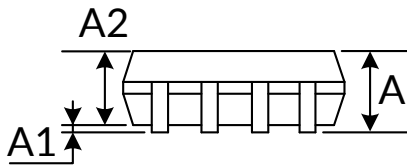

Figure 10. 0.1Hz to 10Hz Noise

## 8 PACKAGE OUTLINE DIMENSIONS MSOP8<sup>(3)</sup>



RECOMMENDED LAND PATTERN (Unit: mm)



Symbol	Dimensions In Millimeters		Dimensions In Inches	
	Min	Max	Min	Max
A <sup>(1)</sup>	0.820	1.100	0.032	0.043
A1	0.020	0.150	0.001	0.006
A2	0.750	0.950	0.030	0.037
b	0.250	0.380	0.010	0.015
c	0.090	0.230	0.004	0.009
D <sup>(1)</sup>	2.900	3.100	0.114	0.122
e	0.650(BSC) <sup>(2)</sup>		0.026(BSC) <sup>(2)</sup>	
E <sup>(1)</sup>	2.900	3.100	0.114	0.122
E1	4.750	5.050	0.187	0.199
L	0.400	0.800	0.016	0.031
$\theta$	0°	6°	0°	6°

NOTE:

1. Plastic or metal protrusions of 0.15mm maximum per side are not included.
2. BSC (Basic Spacing between Centers), "Basic" spacing is nominal.
3. This drawing is subject to change without notice.

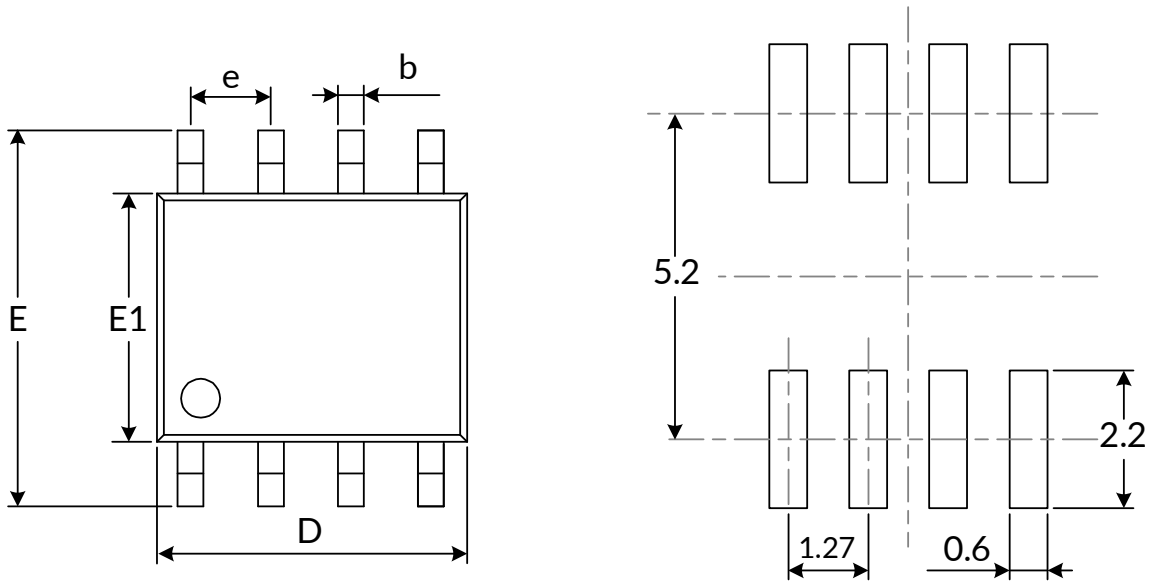
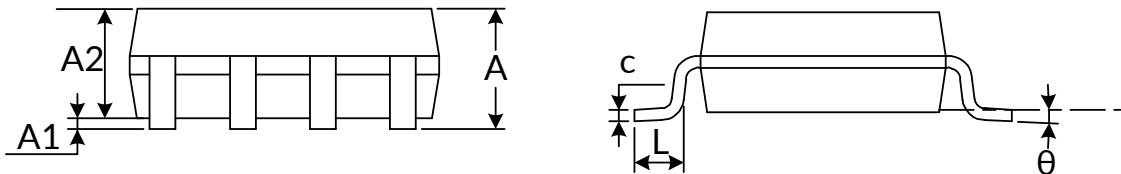
**SOP8<sup>(3)</sup>**

**RECOMMENDED LAND PATTERN (Unit: mm)**

Symbol	Dimensions In Millimeters		Dimensions In Inches	
	Min	Max	Min	Max
A <sup>(1)</sup>	1.350	1.750	0.053	0.069
A1	0.100	0.250	0.004	0.010
A2	1.350	1.550	0.053	0.061
b	0.330	0.510	0.013	0.020
c	0.170	0.250	0.007	0.010
D <sup>(1)</sup>	4.800	5.000	0.189	0.197
e	1.270(BSC) <sup>(2)</sup>		0.050(BSC) <sup>(2)</sup>	
E	5.800	6.200	0.228	0.244
E1 <sup>(1)</sup>	3.800	4.000	0.150	0.157
L	0.400	1.270	0.016	0.050
θ	0°	8°	0°	8°

**NOTE:**

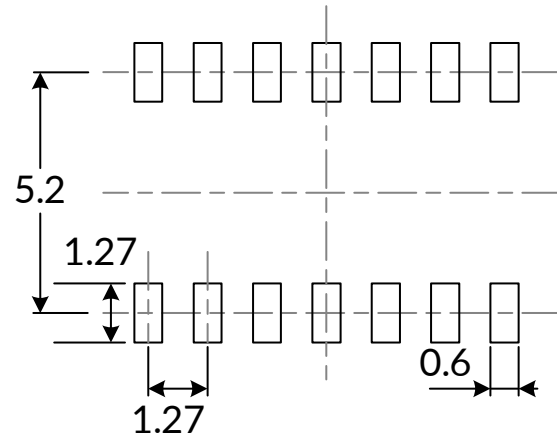
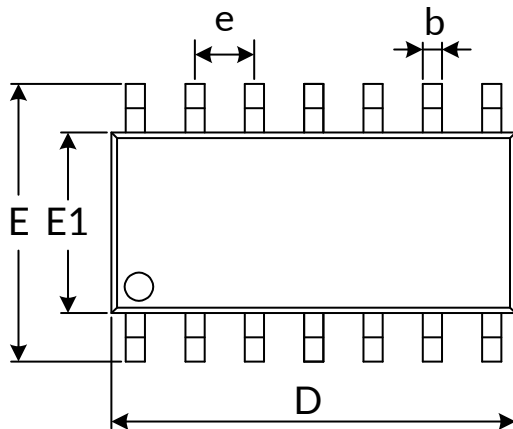
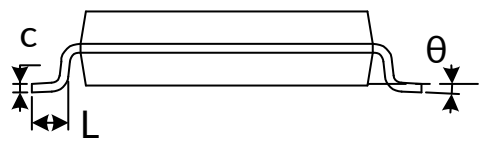
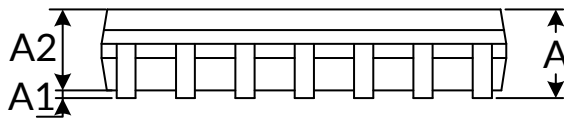
1. Plastic or metal protrusions of 0.15mm maximum per side are not included.
2. BSC (Basic Spacing between Centers), "Basic" spacing is nominal.
3. This drawing is subject to change without notice.

**SOP14<sup>(3)</sup>**

**RECOMMENDED LAND PATTERN (Unit: mm)**

Symbol	Dimensions In Millimeters		Dimensions In Inches	
	Min	Max	Min	Max
A <sup>(1)</sup>	1.350	1.750	0.053	0.069
A1	0.100	0.250	0.004	0.010
A2	1.350	1.550	0.053	0.061
b	0.310	0.510	0.012	0.020
c	0.100	0.250	0.004	0.010
D <sup>(1)</sup>	8.450	8.850	0.333	0.348
e	1.270(BSC) <sup>(2)</sup>		0.050(BSC) <sup>(2)</sup>	
E	5.800	6.200	0.228	0.244
E1 <sup>(1)</sup>	3.800	4.000	0.150	0.157
L	0.400	1.270	0.016	0.050
$\theta$	0°	8°	0°	8°

**NOTE:**

1. Plastic or metal protrusions of 0.15mm maximum per side are not included.
2. BSC (Basic Spacing between Centers), "Basic" spacing is nominal.
3. This drawing is subject to change without notice.

## 9 TAPE AND REEL INFORMATION

### REEL DIMENSIONS

### TAPE DIMENSION

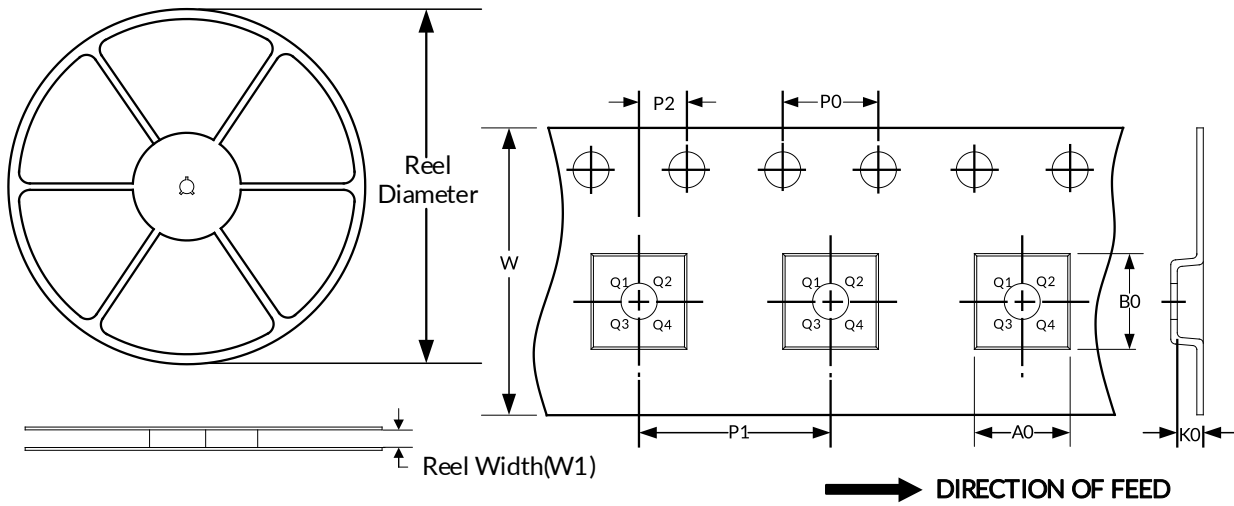

NOTE: The picture is only for reference. Please make the object as the standard.

### KEY PARAMETER LIST OF TAPE AND REEL

Package Type	Reel Diameter	Reel Width W1(mm)	A0 (mm)	B0 (mm)	K0 (mm)	P0 (mm)	P1 (mm)	P2 (mm)	W (mm)	Pin1 Quadrant
SOP8	13"	12.4	6.40	5.40	2.10	4.0	8.0	2.0	12.0	Q1
MSOP8	13"	12.4	5.20	3.30	1.50	4.0	8.0	2.0	12.0	Q1
SOP14	13"	16.4	6.60	9.30	2.10	4.0	8.0	2.0	16.0	Q1

NOTE:

1. All dimensions are nominal.
2. Plastic or metal protrusions of 0.15mm maximum per side are not included.

## **IMPORTANT NOTICE AND DISCLAIMER**

Jiangsu Runic Technology Co., Ltd. will accurately and reliably provide technical and reliability data (including data sheets), design resources (including reference designs), application or other design advice, WEB tools, safety information and other resources, without warranty of any defect, and will not make any express or implied warranty, including but not limited to the warranty of merchantability Implied warranty that it is suitable for a specific purpose or does not infringe the intellectual property rights of any third party.

These resources are intended for skilled developers designing with Runic products You will be solely responsible for: (1) Selecting the appropriate products for your application; (2) Designing, validating and testing your application; (3) Ensuring your application meets applicable standards and any other safety, security or other requirements; (4) Runic and the Runic logo are registered trademarks of Runic Incorporated. All trademarks are the property of their respective owners; (5) For change details, review the revision history included in any revised document. The resources are subject to change without notice. Our company will not be liable for the use of this product and the infringement of patents or third-party intellectual property rights due to its use.