

150mA, Low Power Consumption, High Voltage CMOS LDO Regulator

1 FEATURES

- Low Quiescent Current I_Q :
2uA Typical at Light Loads
- 150mA Nominal Output Current
- Low Dropout Voltage
- Low Temperature Coefficient
- High Input Voltage (up to 36V)
- Output Voltage Accuracy: $\pm 2\%$
- Fixed 2.5V 、 3.0V 、 3.3V、 3.6V and 5V Output Voltage
- Over temperature protection
- Short Circuit Protection
- Micro SIZE PACKAGES: SOT23-3 and SOT89-3

2 APPLICATIONS

- Audio/Video Equipment
- Communication Equipment
- Battery-Powered Equipment
- Automotive Head Unit
- Laptop, Palmtops, Notebook Computers

3 DESCRIPTIONS

The RS75xx-1 series is a set of low power high voltage regulators implemented in CMOS technology. Which can provide 150mA output current. The device allows input voltage as high as 36V. It is very suitable for multi-cell battery systems, bus voltage power supply systems and other high DC voltage systems. Wide input voltage can make it well withstand the impact of surge voltage and ensure the stability of output voltage.

The RS75xx-1 series only 2uA (typical) current is consumed by itself, which is especially important in multi-battery power supply systems and can reduce the standby power consumption of the whole system.

The RS75xx-1 is available in Green SOT23-3 and SOT89-3 packages. The over temperature is 150 °C.

Device Information (1)

PART NUMBER	PACKAGE	BODY SIZE (NOM)
RS75xx-1	SOT23-3	1.60mm×2.92mm
	SOT89-3	2.45mm×4.50mm

Note: xx represents output voltage

4 Typical Application Schematic

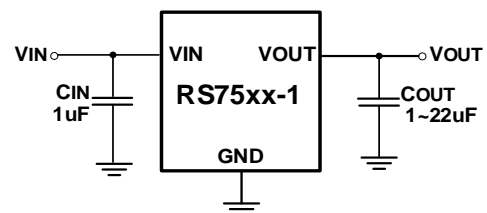

Table of Contents

1 FEATURES	1
2 APPLICATIONS	1
3 DESCRIPTIONS	1
4 Typical Application Schematic	1
5 Revision History	3
6 PACKAGE/ORDERING INFORMATION ⁽¹⁾	4
7 Pin Configuration and Functions (Top View)	5
8 Specifications	6
8.1 Absolute Maximum Ratings	6
8.2 ESD Ratings	6
8.3 Recommended Operating Conditions	6
8.4 Thermal Information	6
8.5 ELECTRICAL CHARACTERISTICS	7
8.6 TYPICAL CHARACTERISTICS	9
9 DETAILED DESCRIPTION	11
9.1 Overview	11
9.2 Functional Block Diagram	11
9.3 Thermal Considerations	11
9.4 Applications Note:	11
10 PACKAGE OUTLINE DIMENSIONS	12
11 TAPE AND REEL INFORMATION	14

5 Revision History

Note: Page numbers for previous revisions may differ from page numbers in the current version.

VERSION	Change Date	Change Item
A.10	2023/05/08	1.Update Typical Application Schematic on Page 1 @A.9 Version. 2.Increase Power Dissipation and Junction Temperature Range on Page 4 @A.9 Version. 3.Increase RS7533-1YF3-G ORDERING NUMBER on Page 3 @A.9 Version.
A.10.1	2024/03/07	Modify packaging naming

6 PACKAGE/ORDERING INFORMATION ⁽¹⁾

PRODUCT	ORDERING NUMBER	V _{OUT} (V)	PACKAGE LEAD	PACKAGE MARKING ⁽²⁾	PACKAGE OPTION
RS7525-1	RS7525-1YF3	2.5	SOT23-3	7525-1	Tape and Reel,3000
	RS7525-1YE3L	2.5	SOT89-3(L-Type)	7525-1	Tape and Reel,1000
RS7530-1	RS7530-1YF3	3.0	SOT23-3	7530-1	Tape and Reel,3000
	RS7530-1YE3L	3.0	SOT89-3(L-Type)	7530-1	Tape and Reel,1000
RS7533-1	RS7533-1YF3	3.3	SOT23-3	7533-1	Tape and Reel,3000
	RS7533-1YE3	3.3	SOT89-3	7533-E	Tape and Reel,1000
	RS7533-1YE3L	3.3	SOT89-3(L-Type)	7533-1	Tape and Reel,1000
	RS7533-1YF3-G ⁽³⁾	3.3	SOT23-3	7533-1	Tape and Reel,3000
RS7536-1	RS7536-1YF3	3.6	SOT23-3	7536-1	Tape and Reel,3000
	RS7536-1YE3L	3.6	SOT89-3(L-Type)	7536-1	Tape and Reel,1000
RS7550-1	RS7550-1YF3	5.0	SOT23-3	7550-1	Tape and Reel,3000
	RS7550-1YE3	5.0	SOT89-3	7550-E	Tape and Reel,1000
	RS7550-1YE3L	5.0	SOT89-3(L-Type)	7550-1	Tape and Reel,1000

NOTE:

- (1) This information is the most current data available for the designated devices. This data is subject to change without notice and revision of this document. For browser-based versions of this data sheet, refer to the right-hand navigation.
- (2) There may be additional marking, which relates to the lot trace code information (data code and vendor code), the logo or the environmental category on the device.
- (3) -G represents MSL 1. MSL, The Moisture Sensitivity Level rating according to the JEDEC industry standard classifications.

7 Pin Configuration and Functions (Top View)

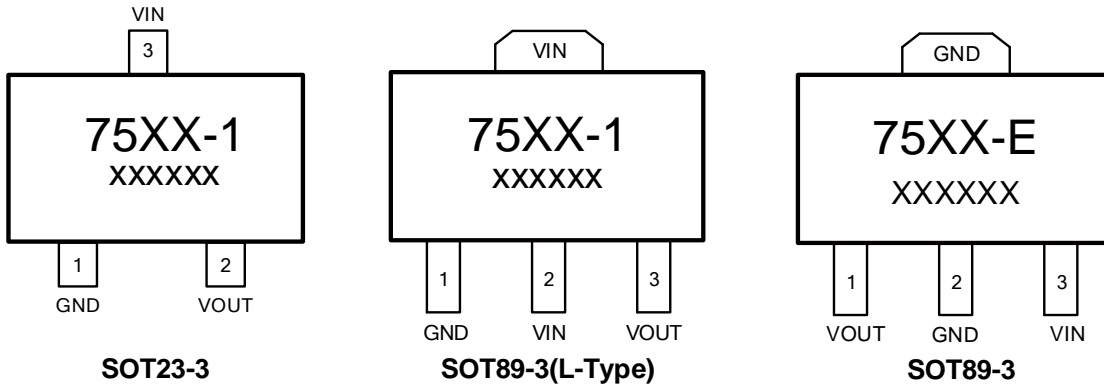

PIN DESCRIPTION

NAME	PIN			FUNCTION
	SOT23-3	SOT89-3(L-Type)	SOT89-3	
GND	1	1	2	Ground.
VIN	3	2	3	Regulator Input. Up to 36V input voltage. At least 1 uF supply bypass capacitor is recommended.
VOUT	2	3	1	Regulator Output. Recommended output capacitor range: 1uF to 10uF.

8 Specifications

8.1 Absolute Maximum Ratings

over operating free-air temperature range (unless otherwise noted) ⁽¹⁾ ⁽²⁾

		MIN	MAX	UNIT
V _{IN}	Input voltage	-0.3	40	V
T _J	PN Junction temperature	-40	150	°C
T _{stg}	Storage temperature range	-65	150	°C

(1) Stresses beyond those listed under *Absolute Maximum Ratings* may cause permanent damage to the device. These are stress ratings only, and functional operation of the device at these or any other conditions beyond those indicated under *Recommended Operating Conditions* is not implied. Exposure to absolute-maximum-rated conditions for extended periods may affect device reliability.

(2) All voltages are with respect to the GND pin.

8.2 ESD Ratings

The following ESD information is provided for handling of ESD-sensitive devices in an ESD protected area only.

		VALUE	UNIT
V _(ESD)	Electrostatic discharge	Human-body model (HBM), per ANSI/ESDA/JEDEC JS-001 ⁽¹⁾	±4000 V
		Machine model (MM)	±100 V

(1) JEDEC document JEP155 states that 500 V HBM allows safe manufacturing with a standard ESD control process.



ESD SENSITIVITY CAUTION

ESD damage can range from subtle performance degradation to complete device failure. Precision integrated circuits may be more susceptible to damage because very small parametric changes could cause the device not to meet its published specifications.

8.3 Recommended Operating Conditions

over operating free-air temperature range (unless otherwise noted) ⁽¹⁾

		MIN	MAX	UNIT
V _{IN}	Input supply voltage	2.5	36	V
I _{OUT}	Output current	0	150	mA
C _{OUT}	Capacitor of V _{OUT} pin	1	22	µF
T _J	Junction Temperature Range ⁽²⁾	-40	+85	°C
T _A	Operating temperature	-40	+85 ⁽³⁾	°C

(1) All voltage is with respect to the GND pin.

(2) The maximum power dissipation is a function of T_{J(MAX)}, R_{θJA}, and T_A. The maximum allowable power dissipation at any ambient temperature is P_D = (T_{J(MAX)} - T_A) / R_{θJA}. All numbers apply for packages soldered directly onto a PCB

(3) The chip's operating temperature is determined by the junction temperature (T_J), the relationship between T_A and T_J, Please refer to the application note as below.

8.4 Thermal Information

THERMAL METRIC		RS75xx-1			UNIT
		SOT89-3 (L-Type)	SOT89-3	SOT23-3	
		3 PINS	3 PINS	3 PINS	
R _{θJA}	Junction-to-ambient thermal resistance	208.3	75	312.5	°C/W
P _D	Power Dissipation ⁽¹⁾	0.6	1.7	0.4	W

(1) Internal thermal shutdown circuitry protects the device from permanent damage. The actual chip output current is subject to the input-output voltage difference, ambient temperature and PCB heat dissipation design.

8.5 ELECTRICAL CHARACTERISTICS

($V_{IN} = V_{OUT} + 2V$, $C_{IN} = C_{OUT} = 1\mu F$, $V_{OUT} = 3.3V$, Full = $-40^{\circ}C$ to $+85^{\circ}C$, typical values are at $T_A = +25^{\circ}C$, unless otherwise noted.)

PARAMETER	SYMBOL	CONDITIONS	TEMP	MIN	TYP	MAX	UNITS
Input Voltage ⁽¹⁾	V_{IN}	$V_{OUT} = 3.3V$	$+25^{\circ}C$	-	-	36	V
Output Voltage Accuracy		$I_{OUT} = 10mA$	$+25^{\circ}C$	-2	0	2	%
Ground Pin Current		No load	$+25^{\circ}C$	-	2	3	μA
Maximum Output Current ⁽²⁾			$+25^{\circ}C$	70	100	-	mA
Dropout Voltage ⁽³⁾	V_{DROP}	$I_{OUT} = 100mA$, $\Delta V_o = 2\%$	$+25^{\circ}C$	-	526	800	mV
Line Regulation	$\frac{\Delta V_{OUT}}{\Delta V_{IN} \times V_{OUT}}$	$V_{IN} = V_{OUT} + 2V$ to $36V$, $I_{OUT} = 1mA$	$+25^{\circ}C$		0.05	0.2	%/V
Load Regulation	ΔV_{OUT}	$V_{IN} = V_{OUT} + 2V$, $I_{OUT} = 1mA$ to $50mA$	$+25^{\circ}C$		25	60	mV
Power Supply Rejection Ratio	PSRR	$V_{OUT} = 3.3V$, $I_{OUT} = 10mA$	$+25^{\circ}C$		58		dB
				$f = 217Hz$	40		
Output Voltage Temperature Coefficient ⁽⁴⁾	$\frac{\Delta V_{OUT}}{\Delta T_A \times V_{OUT}}$	$I_{OUT} = 1mA$	FULL		100		ppm/ $^{\circ}C$
THERMAL PROTECTION							
Thermal Shutdown Temperature	T_{SHDN}				150		$^{\circ}C$

NOTES:

- $V_{IN} \geq V_{OUT (NOMINAL)}$, whichever is greater.
- Maximum output current is affected by the PCB layout, size of metal trace, the thermal conduction path between metal layers, ambient temperature and the other environment factors of system. Attention should be paid to the dropout voltage when $V_{IN} < V_{OUT} + V_{DROP}$.
- The dropout voltage is defined as $V_{IN} - V_{OUT}$, when V_{OUT} is 100mV below the value of V_{OUT} for $V_{IN} = V_{OUT (NOMINAL)} + 2V$.
- Output voltage temperature coefficient is defined as the worst-case voltage change divided by the total temperature range.

ELECTRICAL CHARACTERISTICS

($V_{IN} = V_{OUT} + 2V$, $C_{IN} = C_{OUT} = 1\mu F$, $V_{OUT} = 5.0V$, Full = $-40^{\circ}C$ to $+85^{\circ}C$, typical values are at $T_A = +25^{\circ}C$, unless otherwise noted.)

PARAMETER	SYMBOL	CONDITIONS	TEMP	MIN	TYP	MAX	UNITS
Input Voltage ⁽¹⁾	V_{IN}	$V_{OUT} = 5.0V$	$+25^{\circ}C$	-	-	36	V
Output Voltage Accuracy		$I_{OUT} = 10mA$	$+25^{\circ}C$	-2	0	2	%
Ground Pin Current		No load $V_{IN} = V_{OUT} + 2V$	$+25^{\circ}C$	-	2	3	μA
Maximum Output Current ⁽²⁾			$+25^{\circ}C$	100	150	-	mA
Dropout Voltage ⁽³⁾	V_{DROP}	$I_{OUT} = 100mA$, $\Delta V_o = 2\%$	$+25^{\circ}C$	-	440	700	mV
Line Regulation	$\frac{\Delta V_{OUT}}{\Delta V_{IN} \times V_{OUT}}$	$V_{IN} = V_{OUT} + 2V$ to 36V, $I_{OUT} = 1mA$	$+25^{\circ}C$		0.05	0.2	%/V
Load Regulation	ΔV_{OUT}	$V_{IN} = V_{OUT} + 2V$, $I_{OUT} = 1mA$ to 150mA	$+25^{\circ}C$		25	60	mV
Power Supply Rejection Ratio	PSRR	$V_{OUT} = 5.0V$, $I_{OUT} = 10mA$	$+25^{\circ}C$		58		dB
				$f = 217Hz$		40	
Output Voltage Temperature Coefficient ⁽⁴⁾	$\frac{\Delta V_{OUT}}{\Delta T_A \times V_{OUT}}$	$I_{OUT} = 1mA$	FULL		100		ppm/ $^{\circ}C$
THERMAL PROTECTION							
Thermal Shutdown Temperature	T_{SHDN}				150		$^{\circ}C$

NOTES:

- $V_{IN} \geq V_{OUT (NOMINAL)}$, whichever is greater.
- Maximum output current is affected by the PCB layout, size of metal trace, the thermal conduction path between metal layers, ambient temperature and the other environment factors of system. Attention should be paid to the dropout voltage when $V_{IN} < V_{OUT} + V_{DROP}$.
- The dropout voltage is defined as $V_{IN} - V_{OUT}$, when V_{OUT} is 100mV below the value of V_{OUT} for $V_{IN} = V_{OUT (NOMINAL)} + 2V$.
- Output voltage temperature coefficient is defined as the worst-case voltage change divided by the total temperature range.

8.6 TYPICAL CHARACTERISTICS

NOTE: The graphs and tables provided following this note are a statistical summary based on a limited number of samples and are provided for informational purposes only.

$V_{IN} = 5.3V$, $V_{OUT} = 3.0V$, $C_{IN} = C_{OUT} = 1\mu F$, $T_A = 25^\circ C$ unless otherwise noted.

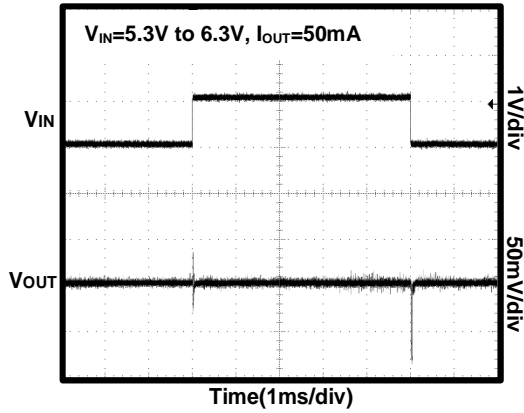

Figure 1. Line-Transient Response

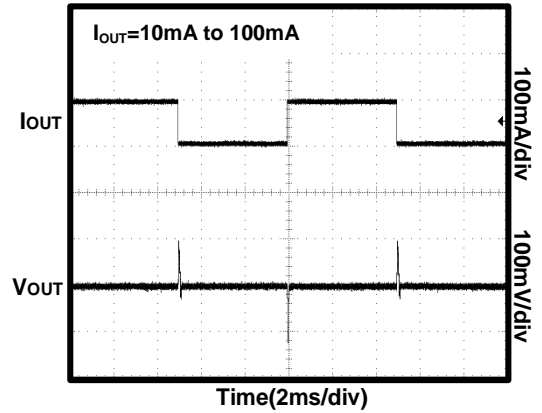

Figure 2. Load-Transient Response

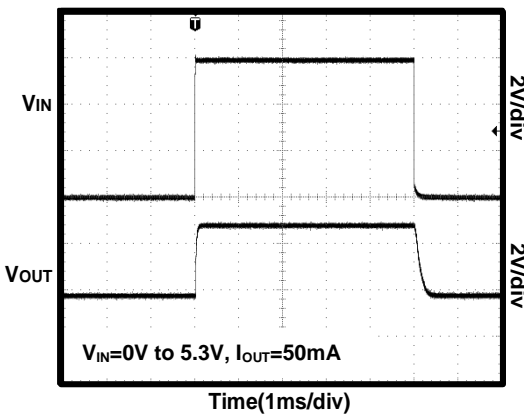

Figure 3. Power-Up/Power-Down Output Waveform

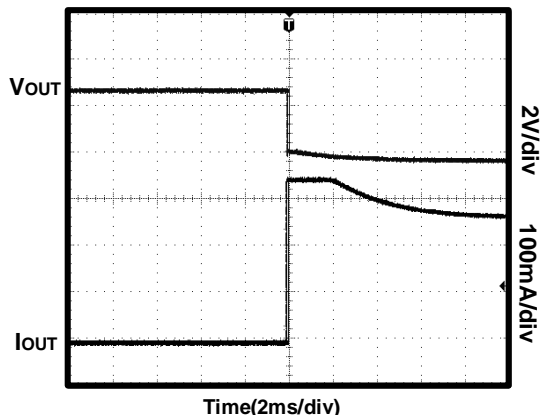

Figure 4. Output Short Waveform

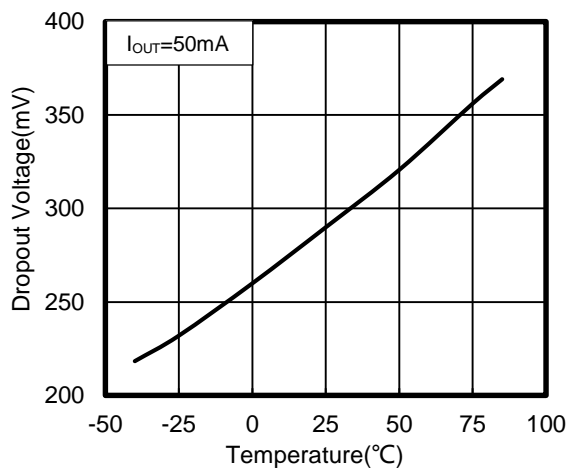

Figure 5. Dropout Voltage vs Temperature

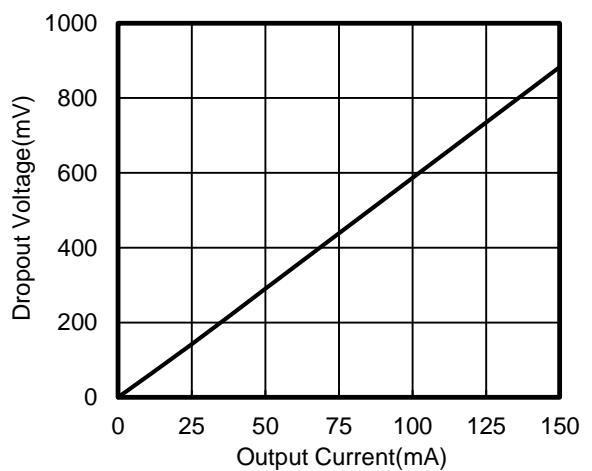

Figure 6. Dropout Voltage vs Output Current

TYPICAL CHARACTERISTICS

NOTE: The graphs and tables provided following this note are a statistical summary based on a limited number of samples and are provided for informational purposes only.

$V_{IN} = 5.3V$, $V_{OUT} = 3.0V$, $C_{IN} = C_{OUT} = 1\mu F$, $T_A = 25^\circ C$ unless otherwise noted.

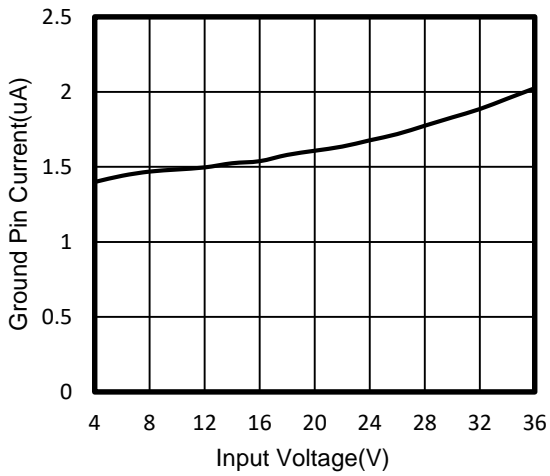

Figure 7. Ground Pin Current vs Input Voltage

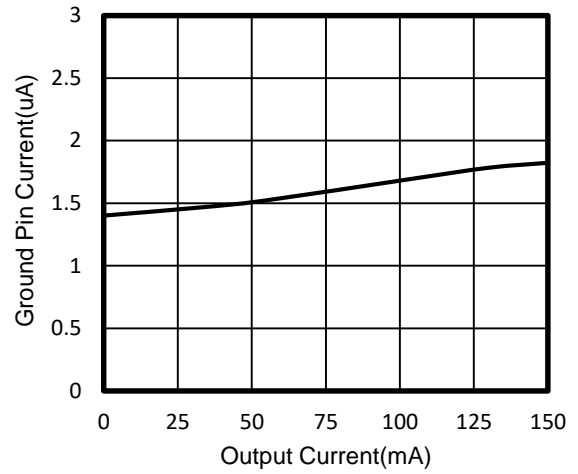

Figure 8. Ground Pin Current vs Load Current

9 DETAILED DESCRIPTION

9.1 Overview

The RS75xx-1 low-dropout regulators (LDO) consumes only 2 μ A of quiescent current at light load and delivers excellent line and load transient performance. These characteristics, combined with low noise and good PSRR with low dropout voltage, make this device ideal for portable consumer applications.

9.2 Functional Block Diagram

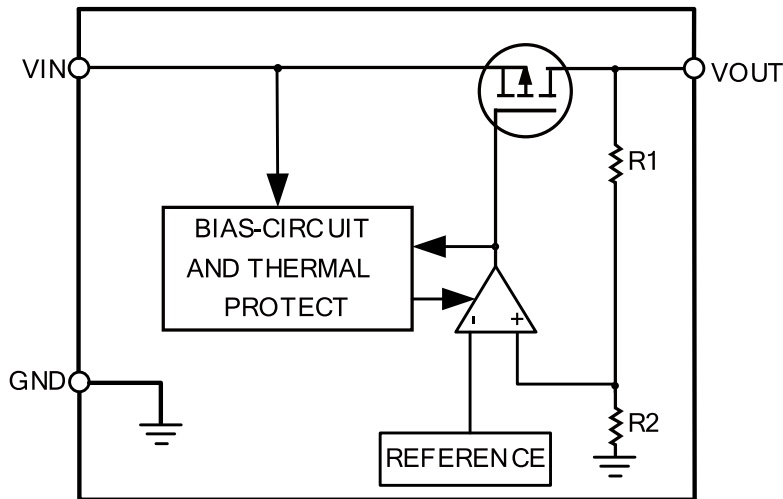

9.3 Thermal Considerations

When the junction temperature is too high, the thermal protection circuitry sends a signal to the control logic that will shut down the IC. The IC will restart when the temperature has sufficiently cooled down. The maximum power dissipation is dependent on the thermal resistance of the case and the circuit board, the temperature difference between the die junction and the ambient air, and the rate of air flow. The GND pin must be connected to the ground plane for proper dissipation.

9.4 Applications Note:

- 1) The phase compensation circuit and ESR of the output capacitor are used inside the circuit to compensate, so a capacitor larger than 1.0 μ F must be connected to the ground.
- 2) It is recommended to use 1 μ F polar capacitors for input and output, and to keep the capacitors as close to the VIN and VOUT pins of LDO as possible.
- 3) Pay attention to the use conditions of input and output voltages and load currents to avoid the power consumption (PD) inside the IC exceeding the maximum power consumption allowed by the package.

$$PD=(V_{IN}-V_{OUT}) \times I_{OUT}$$

$$T_{PN} = PD \times R_{\theta JA} + T$$

T_{PN} is junction temperature

T is ambient temperature

- 4) When the input voltage V_{IN} is greater than 2.5V, if V_{IN} is also higher than the output set value plus the device dropout voltage, V_{OUT} is equal to the set value. Otherwise, V_{OUT} is equal to V_{IN} minus the dropout voltage. If V_{IN} lower than 2.5V, the V_{OUT} is:

$$V_{OUT} = V_{IN} - V_{Dropout}$$

10 PACKAGE OUTLINE DIMENSIONS

SOT23-3

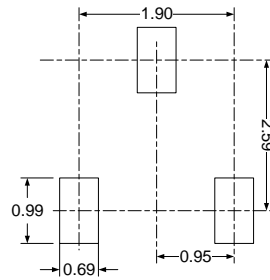
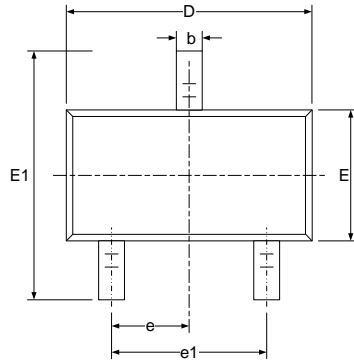

RECOMMENDED LAND PATTERN (Unit: mm)

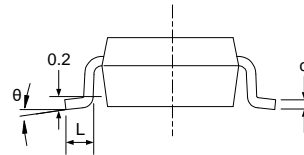
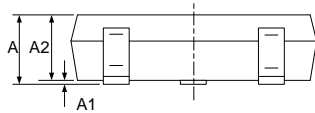

Symbol	Dimensions In Millimeters		Dimensions In Inches	
	Min	Max	Min	Max
A	1.050	1.250	0.041	0.049
A1	0.000	0.100	0.000	0.004
A2	1.050	1.150	0.041	0.045
b	0.300	0.500	0.012	0.020
c	0.100	0.200	0.004	0.008
D	2.820	3.020	0.111	0.119
E	1.500	1.700	0.059	0.067
E1	2.650	2.950	0.104	0.116
e	0.950(BSC)		0.037(BSC)	
e1	1.800	2.000	0.071	0.079
L	0.300	0.600	0.012	0.024
θ	0°	8°	0°	8°

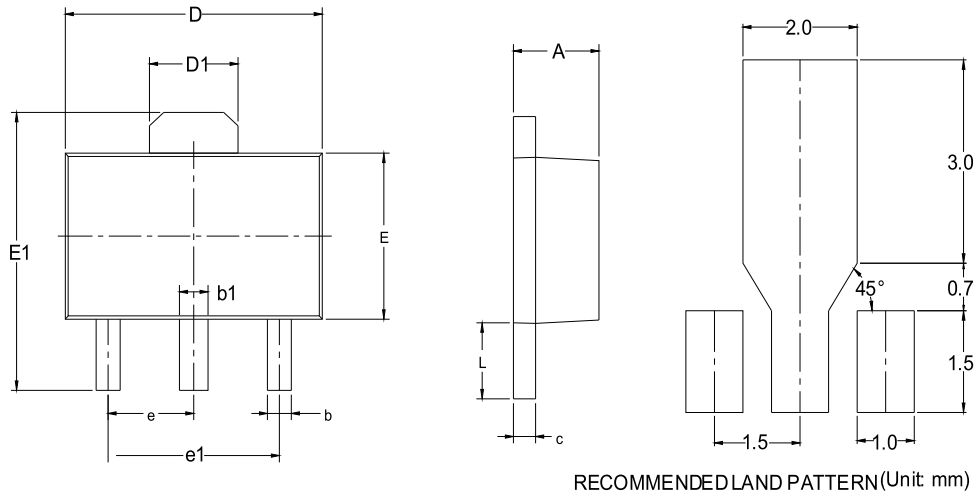
SOT89-3

Symbol	Dimensions In Millimeters		Dimensions In Inches	
	Min	Max	Min	Max
A	1.400	1.600	0.055	0.063
b	0.320	0.520	0.013	0.020
b1	0.400	0.580	0.016	0.023
c	0.350	0.440	0.014	0.017
D	4.400	4.600	0.173	0.181
D1	1.550 REF		0.061 REF	
E	2.300	2.600	0.091	0.102
E1	3.940	4.250	0.155	0.167
e	1.500 BSC		0.060 BSC	
e1	3.000 BSC		0.118 BSC	
L	0.900	1.200	0.035	0.047

NOTE:

- A. All linear dimension is in millimeters.
- B. This drawing is subject to change without notice.
- C. Body dimensions do not include mold flash or protrusion. Mold flash and protrusion shall not exceed 0.15 per side.
- D. BSC: Basic Dimension. Theoretically exact value shown without tolerances.
- E. REF: Reference Dimension, usually without tolerance, for information purposes only.

11 TAPE AND REEL INFORMATION

REEL DIMENSIONS

TAPE DIMENSION

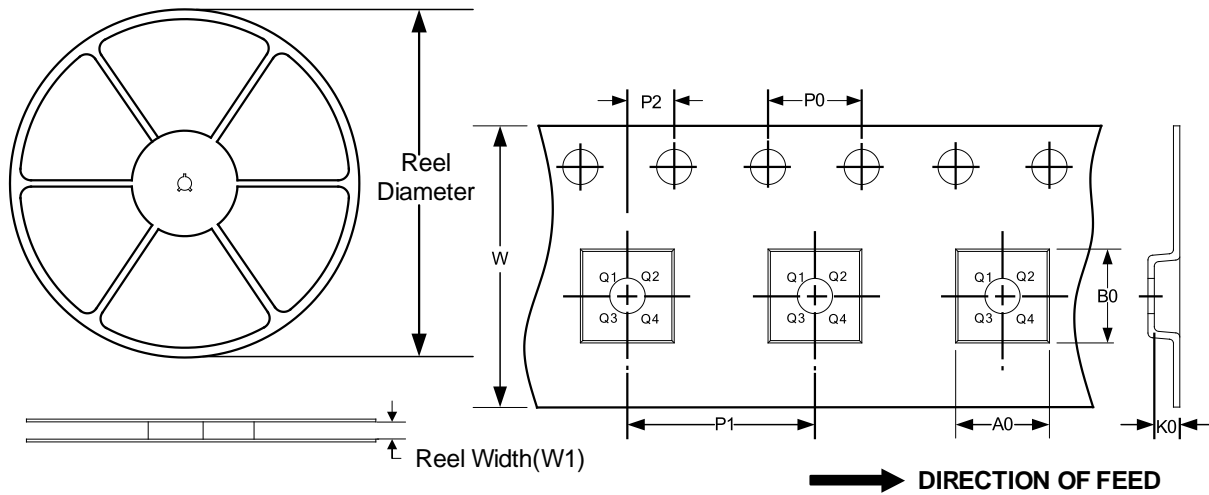

NOTE: The picture is only for reference. Please make the object as the standard.

KEY PARAMETER LIST OF TAPE AND REEL

Package Type	Reel Diameter	Reel Width(mm)	A0 (mm)	B0 (mm)	K0 (mm)	P0 (mm)	P1 (mm)	P2 (mm)	W (mm)	Pin1 Quadrant
SOT23-3	7"	9.0	3.20	3.30	1.30	4.0	4.0	2.0	8.0	Q3
SOT89-3	7"	13.2	4.85	4.45	1.85	4.0	8.0	2.0	12.0	Q3

NOTE:

1. All dimensions are nominal.
2. Plastic or metal protrusions of 0.15mm maximum per side are not included.

IMPORTANT NOTICE AND DISCLAIMER

Jiangsu Runic Technology Co., Ltd. will accurately and reliably provide technical and reliability data (including data sheets), design resources (including reference designs), application or other design advice, WEB tools, safety information and other resources, without warranty of any defect, and will not make any express or implied warranty, including but not limited to the warranty of merchantability Implied warranty that it is suitable for a specific purpose or does not infringe the intellectual property rights of any third party.

These resources are intended for skilled developers designing with Runic products You will be solely responsible for: (1) Selecting the appropriate products for your application; (2) Designing, validating and testing your application; (3) Ensuring your application meets applicable standards and any other safety, security or other requirements; (4) Runic and the Runic logo are registered trademarks of Runic Incorporated. All trademarks are the property of their respective owners; (5) For change details, review the revision history included in any revised document. The resources are subject to change without notice. Our company will not be liable for the use of this product and the infringement of patents or third-party intellectual property rights due to its use.